



FRANKE

Inovativní kuchyňská centra:
dřezy, baterie, odsavače par
systémy pro třídění odpadů

Prodejní katalog 2008
ceny platné od 1. 3. 2008

Franke. Pro kuchyně bez kompromisu



Franke - kontakt

Otevírací doba:
pondělí - čtvrtek: 8 - 12 13 - 16:30 hod.
pátek: 8 - 12 hod.

Franke s.r.o.
Kolbenova 17
190 00 Praha 9
tel: +420 281 090 431
+420 281 090 432
+420 281 090 433
fax: +420 281 862 027
www.franke.cz



Firma Franke má po celém světě 82 dceřiných společností a cca 8 800 zaměstnanců (údaj z roku 2006)



Deset dobrých důvodů proč se rozhodnout právě pro Franke

Dřez patří do kuchyně stejně jako varná deska nebo lednice. U kuchyňského dřezu strávíte podle statistik přes dvě třetiny veškerého času v kuchyni. Dnes už se nejedná jen o mytí nádobí, ale hlavně o přípravu pokrmů. A právě zde hraje velkou roli správný výběr dřezu s vhodným příslušenstvím. Protože si kuchyň vybíráte na mnoho let, vyberte si nejen dřez, který bude splňovat všechny Vaše funkční i estetické požadavky, ale i praktické doplňky.

Firma Franke jako největší světový výrobce dřezů Vám nabízí ucelený sortiment jak dřezů, tak jejich doplňků (vhodné baterie, přestavovatelné sortery, čisticí prostředky), a také od roku 2006 kuchyňské odsavače par.

Ať si zařizujete malou kuchyňku na chatě nebo vybíráte špičkové designerské zařízení do luxusní vily, můžete se spolehnout, že výrobky firmy Franke Vám budou dlouho spolehlivě sloužit, a proto jejich výběru věnujte patřičnou pozornost.



1. Zkušenost

Za více než 70 let jsme již vyrobili po celém světě více než 70 milionů dřezů, a také každý třetí odsavač par na světě je od firmy Franke.

2. Kvalita

Pro naše výrobky vybíráme ty nejlepší materiály. Vaši spokojenost také zajišťuje kontinuální kontrola technologie výroby.

3. Funkčnost

Dřezy Franke jsou navrhovány ergonomicky, s ohledem na Vaše optimální využívání.

4. Design

Na našich výrobcích se podílejí uznávaní designeři. Výsledkem je mnoho získaných ocenění.

5. Široký sortiment

Nabízíme Vám největší výběr modelů nerezových a fragnitových dřezů.

6. Příslušenství

Velký výběr vhodného příslušenství Vám výrazně usnadní a zpříjemní práci v kuchyni.

7. Ergonomie

Rozměry a uspořádání dřezů odpovídají posledním ergonomickým poznatkům.



8. Inovace

Nápady firmy Franke často přináší nová řešení a stávají se standardy v moderní domácnosti.

9. Ekologie

Ve všech závodech důsledně uplatňujeme ekologickou výrobu. Všechny námi používané materiály jsou plně recyklovatelné. Naše nabídka přestavitelných sorterů Vám usnadní efektivní třídění odpadů.

10. Servis a služby

Podle individuálních přání Vám poskytneme poradenství při prodeji jak typizovaných dřezů, tak i při zakázkové výrobě.



design award
winner
2002



reddot
best of the best



Designpreis der
Bundesrepublik
Deutschland
Nominiert 2004

Nejvhodnější materiály pro výrobu dřezů

Vysoce kvalitní chromniklová ocel (nerez)

- odolná vůči korozi i po porušení povrchu dřezu
- odolná vůči vysokým teplotám
- pružná: na rozdíl od keramiky nepraskne
- hygienická: hladký povrch zabraňuje usazování bakterií a lehce se čistí
- životnost nerezové ocele zatím nepřekonal žádný jiný materiál
- nerezová ocel je plně recyklovatelná

provedení nerez



Franke Fragranit

Materiál je optimálním spojením drcené žuly (80 %) a akrylu (20 %)

- i při zachování charakteru přírodního kamene se snadno udržuje
- odolný vůči teplotám do 280 °C (horké hrnce nepoškodí povrch)
- ve srovnání s keramikou či smaltem je mnohonásobně odolnější vůči poškrábání
- odolný vůči poškození agresivními materiály (např. čisticími prostředky, ovocnými šťávami a vínem)

provedení Fragranit

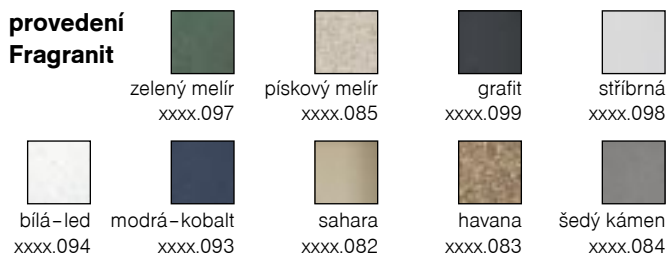

Přehled a sestavení typových čísel Franke (příklad dřez ALG 654/2)

ALG 654/2

/2

 označuje model

AL

 znamenají typovou řadu
např. **ALG 654/2** označují dřezy ATLANTIS

5

 označuje počet dřezů a jejich uspořádání

ALG 654/2

ARX 652 E

 nebo také
E = rohový dřez
2 = odkapávací plocha vpravo
7 = odkapávací plocha vlevo

G

 označuje materiál:

ALG 654/2

nebo také

X = Chromniklová ocel (nerez)

L = Tkaná struktura (nerez)

G = Fragranit

T = Mikrostruktura (nerez)

N = Neleštěná chromniklová ocel (nerez)

ALG 654/2

nebo také

1 = 1 dřez

2 = 2 dřezy + 1/4 dřezu

5 = 1 1/2 dřezu

(1/2 dřezu u odkap. plochy)

6 = 1 1/2 dřezu

7 = 2 1/2 dřezu

8 = 1 1/4 dřezu s nárokem na místo ve spodní skřínce

ALG 654/7

odkapová plocha vlevo



ALG 654/2

odkapová plocha vpravo



6

 označuje skupinu a způsob zabudování

ALG 654/2

nebo také

1 = spodní zabudování

2 = zabudování do roviny

6 = horní montáž

4

 označuje druh a počet odkapávacích ploch

ALG 654/2

nebo také

0 = bez odkapávací plochy

1 = 1 odkapávací plocha

2 = 2 odkapávací plochy

4 = přeпад umístěn na odkapávací ploše

V objednávce prosíme uveďte:

- typ
- velikost
- model
- barvu
- druh ventilu
- příslušenství

Přehled	Fragrarity nerez – horní montáž nerez – zabudování spodní, do roviny baterie, odsavače par	Přehled
Fragranitové dřezy	Mythos, Kubus, Nautilus, Atlantis, Corvette, Milan, Rondo, Diana, Euroform, Calypso	Fragranitové dřezy
Nerezové dřezy	Pure Line Glass, Active Kitchen, Largo, Mythos, Kubus, Planar	PUV, AKX, LAX, MTX, KBX, PPX
Nerezové dřezy	Nautilus, Pamira, Papillon, Atlantis, Ariane	NTX, PMX, PAX, ALX, ARX
Nerezové dřezy	Esprit, Compact, Aquatik, Neptun	EIX, CPX, AQX, NEX
Nerezové dřezy	Diana, Liberta, Galassia, Studio, Armonia, Zodiaco	DIX, LIX, GAX, STX, AMX, ZOX
Nerezové dřezy	Logica, Pulsar, Mikado	LOX, PLX, MOX
Nerezové dřezy	Euroform, Acquario, Pamira, Rondo, Rambla	EFX, ACX, PMN, RBX, RAX
Nerezové dřezy	Eurostar, Argo	ETX, ETN, AGX
Systémy na třídění odpadků	sortery řady 700, 150, koše AE, KEA, sortery Trolley, Cube, Solo	Sortery
Dřezy do žuly, corianu a kerrocku pro spodní zabudování a zabudování do roviny	Active Kitchen, Largo, Planar, Kubus, Papillon, Esprit, Pamira Galassia, Ariane, Beach, Compact, Armonia, Zodiaco	Dřezy do roviny spodní montáž
Dřezové baterie	tlakové, pod okno, beztlakové	Dřezové baterie
Odsavače par	komínové, ostrůvkové, rohové, výsuvné, podvěsné, vestavné	Odsavače par















Přehled dřezů Fragranit

spodní skříňka od mm	zobrazení	typ	rozměry mm	výřez mm	strana
450		CEG 614	780 × 515	dle šablony	28
		MIG 614	780 × 510	dle šablony	30
		ROG 610	∅ 510	dle šablony	32
500		CEG 684	860 × 515	dle šablony	29
		EFG 614 - 78	780 × 475	765 × 460 (rádius 20 mm)	35
		MIG 684	860 × 510	dle šablony	31
600		ALG 654	1 010 × 515	990 × 495	34
		CEG 651	970 × 515	dle šablony	29
		DIG 651	965 × 500	950 × 480	34
		KBG 110 - 50	540 × 440	520 × 420	27
		KBG 160	558 × 460	538 × 440	27
		MIG 660	621 × 510	dle šablony	32















Přehled dřezů Fragranit

spodní skříňka od mm	zobrazení	typ	rozměry mm	výřez mm	strana
600		MIG 651	970 × 510	dle šablony	31
		MTG 611	1 000 × 515	984 × 499 (rádius 10 mm)	25
		MTG 651 - 100	1 000 × 515	984 × 499 (rádius 10 mm)	25
		MTG 651	1 100 × 515	1 080 × 495	24
		NTG 651	1 100 × 510	1 083 × 493	26
900		MTG 620 NOVINKA!	910 × 515	890 × 495 (rádius 10 mm)	26
rohové dřezy		CEG 651 E	1 081 × 600	dle šablony	28
		COG 651 E	960 × 500	dle šablony	33
		EFG 682 E	905 × 505	dle šablony	35
		MIG 651 E	926 × 510	dle šablony	30
		PMG 654 E	950 × 710	dle šablony	33











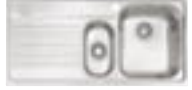

Přehled dřezů nerez horní montáž

spodní skříňka od mm	zobrazení		rozměry mm	výřez mm	strana
300		ETX 110	320 × 435	300 × 415	72
		KBX 610 - 16	200 × 380	dle šablony	44
400		AMX 610	420 × 500	400 × 480	60
		CPX 610	400 × 480	384 × 464	54
		ETN 611 - 58	580 × 510	560 × 490	72
450		AGX 610 - 6/4" AGX 610 - 3 1/2"	420 × 500	400 × 480	74
		AGX 611	790 × 500	770 × 480	74
		AMX 611 AMT 611	860 × 500	840 × 480	60
		AQX 614	780 × 500	760 × 480	55
		CPX 611	780 × 500	764 × 484	54
		DIX 680	625 × 500	608 × 483	58
		ETN 610	455 × 435	435 × 415	72
		KBX 610 - 34	380 × 440	dle šablony	44
		LOX 611 LOL 611	790 × 500	770 × 480	62
		MOX 611	860 × 500	840 × 480	64

Přehled dřezů nerez horní montáž

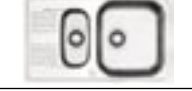
spodní skříňka od mm	zobrazení		rozměry mm	výřez mm	strana
450		PMN 611 PML 611	770 × 500	dle šablony	70
		PPX 610 - 44	440 × 510	420 × 490	46
		RAX 610 - 38 RAL 610 - 38	ø 430	ø 414	71
		RBX 610 - 3 1/2"	ø 440	dle šablony	71
500		ARX 614	895 × 510	878 × 493	51
		EFX 614 EFL 614	800 × 475	780 × 455	66
		EFX 614 - 78 EFL 614 - 78	780 × 475	760 × 455	66
		EIX 611 EIT 611	780 × 510	764 × 494	52
		ETN 614 - 3 1/2" ETL 614 - 3 1/2"	780 × 435	760 × 415	73
		ETX 614 - 3 1/2" NOVINKA!	780 × 435	760 × 415	73
		MTX 611	1 000 × 520	989 × 509 (rádius 10 mm)	43
		NEX 611 NOVINKA!	860 × 510	840 × 490	56
		NTX 684	895 × 510	875 × 493	48
		PMN 610 PML 610	ø 510	dle šablony	71
550		KBX 610 - 45	490 × 440	dle šablony	45















Přehled dřezů nerez horní montáž

spodní skříňka od mm	zobrazení		rozměry mm	výřez mm	strana
550		PUV 611 NOVINKA!	1 000 × 530	980 × 510 (rádius 10 mm)	38
600		AGX 651	1 000 × 500	980 × 480	74
		AKX 654	1 000 × 510	980 × 490	39
		AMX 651 AMT 651	1 000 × 500	980 × 480	60
		AQX 654	965 × 500	945 × 480	55
		ARX 654	1 000 × 510	983 × 493	51
		CPX 660	615 × 500	599 × 484	54
		DIX 660	625 × 500	608 × 483	58
		EFX 651	860 × 500	840 × 480	68
		EFX 651 - 78 NOVINKA	780 × 475	760 × 455	67
		EIX 651 EIT 651	1 000 × 510	984 × 494	52
		GAX 611	1 000 × 500	980 × 480	59
		KBX 610 - 55	590 × 440	dle šablony	45
		LAX 614	1 000 × 510	984 × 494	42
		LOX 651 LOL 651	1 000 × 500	980 × 480	62













Přehled dřezů nerez horní montáž

spodní skříňka od mm	zobrazení		rozměry mm	výřez mm	strana
600		MOX 610 - 575	575 × 505	558 × 488	65
		MOX 651	965 × 500	945 × 480	64
		MOX 651 - 800	800 × 500	780 × 480	64
		MTX 651	1 000 × 520	989 × 509 (rádius 10 mm)	43
		MTX 661	1 000 × 520	989 × 509 (rádius 10 mm)	43
		NEX 651 NOVINKA!	1 000 × 510	980 × 490	56
		NTX 651	1 100 × 510	1 083 × 493	48
		PLX 610	600 × 500	580 × 480	63
		PMN 614 PML 614	770 × 500	dle šablony	70
		PMN 681 PML 681	770 × 500	dle šablony	70
		PPX 610 - 58	580 × 510	560 × 490	46
		PPX 611	1 000 × 510	980 × 490	47
		PPX 651	1 000 × 510	980 × 490	47
		PUV 651 NOVINKA!	1 000 × 530	980 × 510 (rádius 10 mm)	38
		ZOX 660	625 × 500	605 × 480	61

Přehled dřezů nerez horní montáž

spodní skříňka od mm	zobrazení		rozměry mm	výřez mm	strana	
800		AGX 620	790 × 500	770 × 480	75	
		AGX 621	1 160 × 500	1 140 × 480	75	
		AMX 620	860 × 500	840 × 480	61	
		AMX 621	1 160 × 500	1 140 × 480	61	
		EFX 620 - 78 NOVINKA!	780 × 475	760 × 455	67	
		EIX 620	780 × 510	764 × 494	53	
		EIX 621	1 160 × 510	1 144 × 494	53	
		ETN 620	780 × 435	760 × 415	73	
		LOX 620 LOL 620	790 × 500	770 × 480	63	
		NEX 620 NOVINKA!	860 × 510	840 × 490	57	
		NEX 621 NOVINKA!	1 160 × 510	1 140 × 490	57	
		LOX 621	1 160 × 500	1 140 × 480	63	
	900		ACX 610 ACL 610	860 × 500/510	840 × 480	69
			GAX 620	860 × 500	840 × 480	59
1 000		EIX 670	1 000 × 510	984 × 494	53	

Přehled dřezů nerez horní montáž

spodní skříňka od mm	zobrazení		rozměry mm	výřez mm	strana
rohové dřezy		AKX 661 E	1 052 × 515	dle šablony	39
		ALX 661 E ALL 661 E	1 053 × 510	dle šablony	50
		AQX 664 E	960 × 500	dle šablony	55
		ARX 652 E ARL 652 E	1 050 × 510	dle šablony	50
		EFX 682 E	903 × 503	dle šablony	68
		LIX 651 E	960 × 500	dle šablony	58
		MOX 651 E MOL 651 E	960 × 500	dle šablony	65
		MOX 681 E	960 × 500	dle šablony	65
		PMN 681 PML 681	770 × 500	dle šablony	70
		PAX 652 E	965 × 510	dle šablony	49
		PMX 654 E PML 654 E	940 × 710	dle šablony	49
		STX 621 E STL 621 E	830 × 830 × 500	dle šablony	59

Přehled baterií

zobrazení	typ a provedení	str.
-----------	-----------------	------

Tlakové

	FN 050 NOVINKA! (LED diody) chrom	111
	FG 6556 chrom, titan	111
	FG 6787 chrom, titan	111
	FG 7200 chrom	112
	FG 7210 chrom	112
	FG 6753 chrom, titan	112
	FG 6799 chrom	113





zobrazení	typ a provedení	str.
-----------	-----------------	------

Tlakové

	FG 6585 chrom	113
	FG 6587 chrom	113
	FG 0260 chrom, titan, nerez	114
	FG 0261 chrom, titan, nerez	114
	FG 0561 chrom	114
	FG 7400 celonerezová	114
	FK 2100 chrom, nikl-mat	115
	FK 2150 nikl-mat	115

zobrazení	typ a provedení	str.
-----------	-----------------	------







Tlakové

	FG 3600 NOVINKA! chrom, nerez*	115
	FG 3610 NOVINKA! chrom, nerez*	115
	FG 8000 celonerezová	116
	FG 8010 celonerezová	116
	FG 7000 chrom, titan	116
	FG 7010 chrom, titan	116
	FG 3541 chrom, titan, nerez	117
	FG 3550 chrom, titan, nerez	117
	FG 6400 chrom	117

Přehled baterií

zobrazení	typ a provedení	str.
-----------	--------------------	------

Tlakové

	FG 6500 chrom	117
	FG 6100 chrom, titan, nerez, barva	118
	FG 6110 chrom, titan, nerez, barva	118
	FG 7900 chrom, titan, barva	119
	FG 7910 chrom, titan barva	119
	FG 6900 chrom, titan, barva	120
	FG 6800 chrom, titan, barva	120
	FG 9541 chrom, titan, barva	121

zobrazení	typ a provedení	str.
-----------	--------------------	------

Tlakové

	FG 9547 chrom, titan, barva	121
	FG 1839 chrom	122
	FP 5200 chrom, hliník	122
	FP 5000 chrom, hliník	122
	FK 2050 chrom	122
	FP 5100 chrom, hliník	123
	LIG 180 chrom	123
	FP 1800 chrom	123
	FP 1810 chrom	123

zobrazení	typ a provedení	str.
-----------	--------------------	------

















Tlakové – vhodné pro montáž pod okno

	FG 7483 chrom, titan	124
	FG 7481 chrom, titan	124
	FK 2200 chrom, nikl-mat	124
	FG 4500 chrom, titan	125
	FG 4510 chrom, titan	125













Pro beztlakové ohřivače

	FG 6101 chrom	126
	FG 6111 chrom	126
	FG 6301 chrom	126
	FG 6311 chrom	126





Přehled dřezů nerez spodní zabudování, montáž do roviny

spodní skříňka od mm	zobrazení	typ	rozměry mm	výřez typ zabudování	strana
300		AMX 110 - 16	188 × 323	dle šablony spodní zabudování	107
		ARX 110 - 17 S ARX 110 - 17 O	190 × 340	dle šablony spodní zabudování	105
		CPX 110 - 16 S CPX 110 - 16 O	183 × 320	dle šablony spodní zabudování	104
		KBG 110 - 16	187 × 460	dle šablony spodní zabudování	98
		KBX 110 - 16	200 × 380	dle šablony spodní zabudování	100
		KBX 110 - 20	240 × 440	dle šablony spodní zabudování	100
		KBX 210 - 16	190 × 370	dle šablony do roviny	92
		PPX 110 - 16	220 × 450	dle šablony spodní zabudování	102
		PPX 210 - 22	220 × 470	dle šablony do roviny	90
400		GAX 110 - 30	332 × 372	dle šablony spodní zabudování	106
450		AMX 110 - 34	369 × 429	dle šablony spodní zabudování	107
		ARX 110 - 35 S ARX 110 - 35 O	371 × 456	dle šablony spodní zabudování	105
		CPX 110 - 34 S CPX 110 - 34 O	358 × 438	dle šablony spodní zabudování	104
		KBG 110 - 34	367 × 460	dle šablony spodní zabudování	98
		KBX 110 - 34	380 × 440	dle šablony spodní zabudování	100
		KBX 210 - 34	370 × 430	dle šablony do roviny	92





Přehled dřezů nerez spodní zabudování, montáž do roviny

spodní skříňka od mm	zobrazení	typ	rozměry mm	výřez typ zabudování	strana
450		PMX 41	∅ 410	dle šablony spodní zabudování	105
		PPX 110 - 38	420 × 450	dle šablony spodní zabudování	102
		PPX 210 - 44	440 × 470	dle šablony do roviny	90
		ZOX 110 - 36	392 × 452	dle šablony spodní zabudování	106
500		ARX 214	895 × 510	dle šablony do roviny	94
		EIX 211	780 × 510	dle šablony do roviny	95
550		KBX 110 - 45	490 × 440	dle šablony spodní zabudování	101
		KBX 210 - 45	480 × 430	dle šablony do roviny	93
600		AKX 254	1 000 × 510	dle šablony do roviny	89
		AMX 160	567 × 437	dle šablony spodní zabudování	108
		ARX 160	598 × 485	dle šablony spodní zabudování	108
		ARX 254	1 000 × 510	dle šablony do roviny	94
		BBX 160	574 × 440	dle šablony spodní zabudování	97

Přehled dřezů nerez spodní zabudování, montáž do roviny

spodní skříňka od mm	zobrazení	typ	rozměry mm	výřez typ zabudování	strana
600		EIX 251	1 000 × 510	dle šablony do roviny	95
		GAX 110 - 45	482 × 432	dle šablony spodní zabudování	106
		KBG 110 - 50	540 × 440	dle šablony spodní zabudování	99
		KBG 160	558 × 460	dle šablony spodní zabudování	99
		KBX 110 - 55	590 × 440	dle šablony spodní zabudování	101
		KBX 210 - 55	580 × 430	dle šablony do roviny	93
		LAX 110 - 50	524 × 374	dle šablony spodní zabudování	107
		LAX 214	1 000 × 510	dle šablony do roviny	89
		PPX 110 - 52	560 × 450	dle šablony spodní zabudování	102
		PPX 111	980 × 450	dle šablony spodní zabudování	103
		PPX 151	980 × 450	dle šablony spodní zabudování	103
		PPX 210 - 58	580 × 470	dle šablony do roviny	90
		PPX 211	1 000 × 470	dle šablony do roviny	91

Přehled dřezů nerez spodní zabudování, montáž do roviny

spodní skříňka od mm	zobrazení	typ	rozměry mm	výřez typ zabudování	strana
600		PPX 251	1 000 × 470	dle šablony do roviny	91
800		AMX 120	765 × 450	dle šablony spodní zabudování	109
900		GAX 120	830 × 450	dle šablony spodní zabudování	109
rohové dřezy		ALX 261 E	1 053 × 513	dle šablony do roviny	94
		PAX 252 E	965 × 510	dle šablony do roviny	95

Přehled odsavačů par

model	mont. šířka cm	str.
-------	-------------------	------

Kominové

	FSW 908 TC BK XS FSW 908 TC WH XS	90	132
	FAK 907 XS NOVINKA!	90	133
	FNES 907 BTH XS NOVINKA!	90	134
	FNE 908 TC XS NOVINKA!	90	135
	FKU 908 TC XS NOVINKA!	90	136
	FDBA 9078 XS NOVINKA!	90	137
	FAC 907 XS	90	138

model	mont. šířka cm	str.
-------	-------------------	------







Kominové

	FCH 906 - P XS	90	139
	FMY 907 XS	90	140
	FAD 906 - P XS	90	141
	FTU 3807-P XS FTU 3807-P XS 70 H	37	142
	FPL 606 - P XS FPL 906 - P XS	60, 90	143
	FGL 6016 XS FGL 9016 XS	60, 90	144
	FAX 906 XS	90	145
	FGC 906 XS	90	146

Přehled odsavačů par

model	mont. šířka cm	str.
-------	-------------------	------

Kominové

	FDF 6054 - P XS FDF 7054 - P XS FDF 9054 - P XS FDF 12054 - PXS NOVINKA!	60, 70, 90, 120	147
	FDF 6046 XS FDF 6046 XL FDF 6046 XT FDF 9046 XS FDF 9046 XL FDF 9046 XT FDF 9046 AL	60, 90	148
	FDP 12004 XS NOVINKA!	120	149
	FGL 705 - P XS FGL 805 - P XS FGL 905 - P XS	70, 80, 90	150
	FGL 9014 XS NOVINKA!	90	151
	FDL 664 XS FDL 764 XS FDL 964 XS	60, 70, 90	152

model	mont. šířka cm	str.
-------	-------------------	------

Ostrůvkové

	FAK 907 I XS NOVINKA!	90	153
	FDMO 607 I XS NOVINKA!	60	154
	FKU 1008 I TC XS NOVINKA!	100	155
	FPL 457 I XS 645 H FPL 607 I XS 645 H FPL 907 I XS 645 H NOVINKA!	45, 60, 90	156
	FDBA 10078 I XS NOVINKA!	100	157
	FGL 9017 I XS	90	158

model	mont. šířka cm	str.
-------	-------------------	------

Ostrůvkové

	FGC 906 I XS	90	159
	FTU 3807 I XS 77 H	37	160
	FDF 9054 - P I XS NOVINKA!	90	161
	FGL 905 - P I XS NOVINKA!	90	162

Zabudování do rohu

	FFC 905 - P XS NOVINKA!	90 × 90	163
	FDPA 904 XS	90 × 90	163

model	mont. šířka cm	str.
-------	-------------------	------

Vestavné výsuvné

	FTC 6462 XS (k zabudování do skříňky)	60	164
	FTC 622 XS (k zabudování do skříňky)	60	164
	FTC 6032 GR/XS NOVINKA! (k zabudování do skříňky)	60	165

Vestavné

	FBI 502 XS FBI 702 XS	52,2 72,2	165
--	--------------------------	--------------	-----

Podvěsné

	FTF 6052 XS FTF 6032 WH	60	166
--	----------------------------	----	-----

Systémy na třídění odpadků..... str. 78 – 87

Váha, dávkovače a ostatní příslušenství.....str. 167 – 168